

ΤΙ ΚΑΝΟΥΜΕ ΣΕ ΠΕΡΙΠΤΩΣΗ ΣΕΙΣΜΟΥ ΟΤΑΝ ΕΙΜΑΣΤΕ ΣΤΟ ΣΧΟΛΕΙΟ

ΜΕΣΑ ΣΤΟ ΣΧΟΛΕΙΟ
ΠΡΟΒΑΤΕΥΟΜΑΙ
ΜΗΛΙΝΟΝΤΑΣ
ΚΑΤΩ ΑΠΟ ΤΟ ΤΡΑΠΕΖΙ

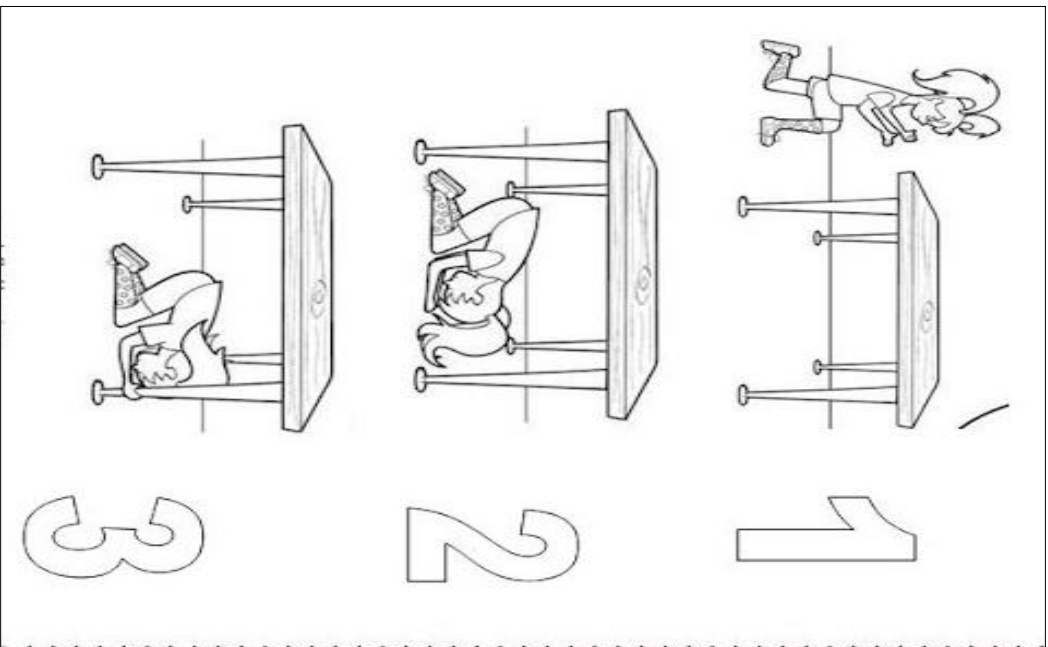

ΒΛΙΝΟΥ ΕΣΘ
ΟΤΑΝ ΠΕΙ Η ΚΥΡΙΑ
ΧΟΡΙΣ ΝΑ ΤΡΕΧΩ
ΤΗΡΩΝΤΑΣ ΤΗ
ΣΕΙΡΑ ΜΟΥ

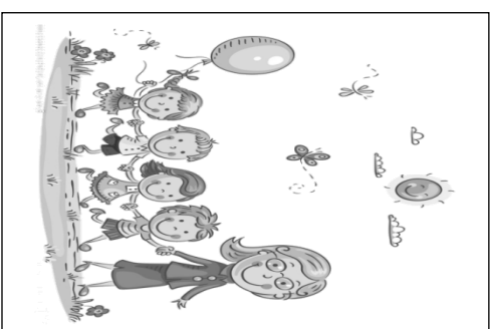
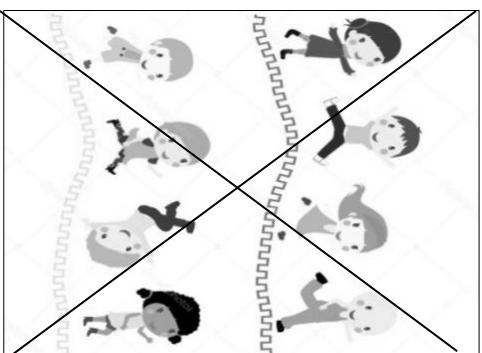
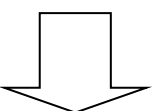
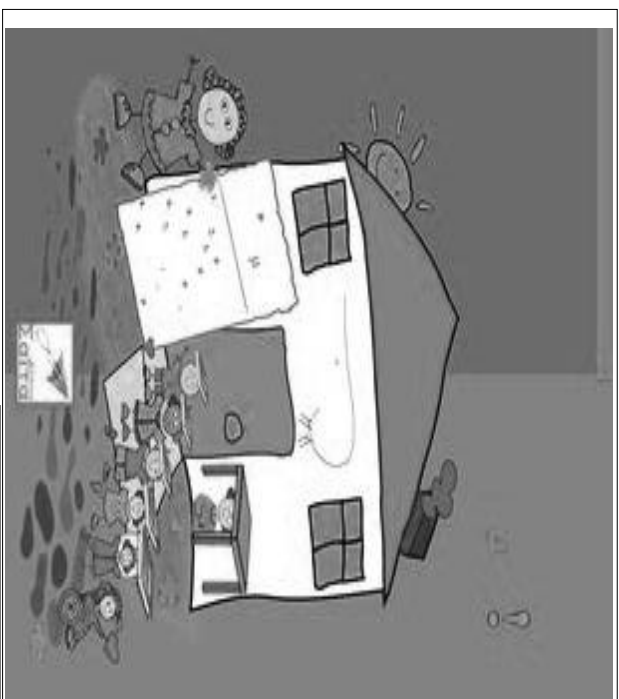

ΠΗΛΙΝΟΥ ΣΤΟ
ΣΗΜΕΙΟ ΜΟΥ
ΘΑ ΜΟΥ ΠΕΙ
Η ΚΥΡΙΑ ΜΟΥ
ΚΑΙ ΠΕΡΙΜΕΝΩ
ΤΟΥΣ ΓΟΝΕΙΣ ΜΟΥ

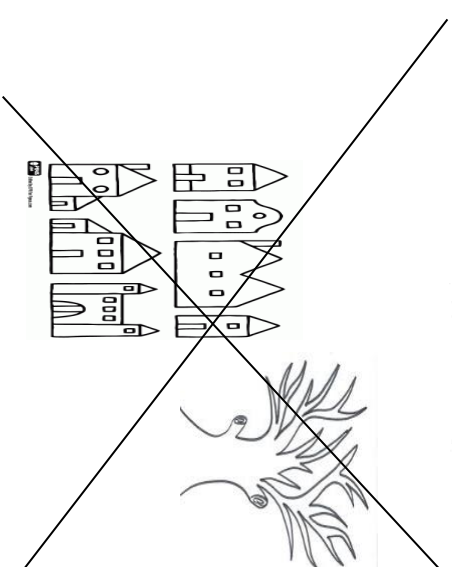
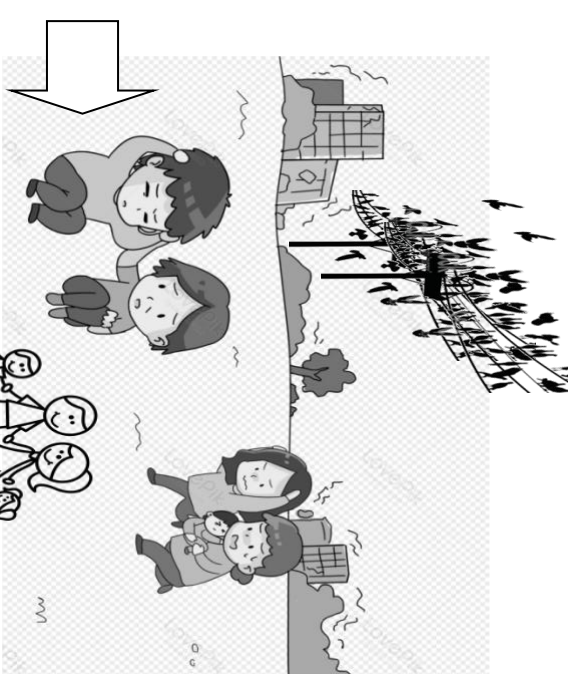

ΤΙ ΘΑ ΕΚΑΝΕΣ ΣΕ ΠΕΡΙΠΤΩΣΗ ΣΕΙΣΜΟΥ; ΚΟΨΕ ΚΑΙ ΚΟΛΛΗΣΕ ΤΙΣ ΕΙΚΟΝΕΣ ΟΝΟΜΑ:.....

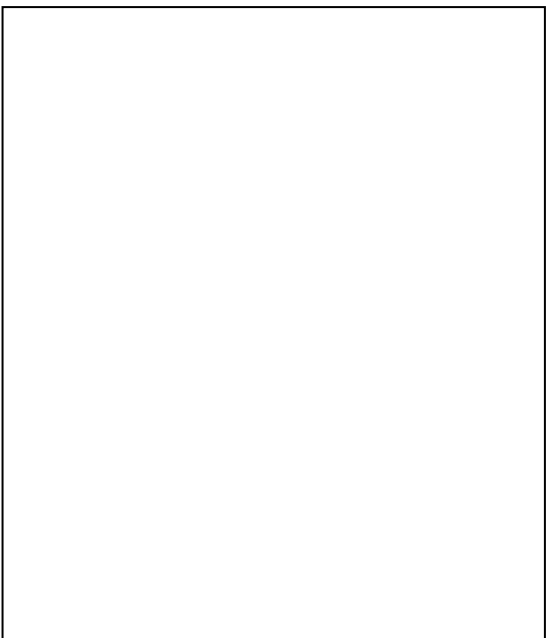
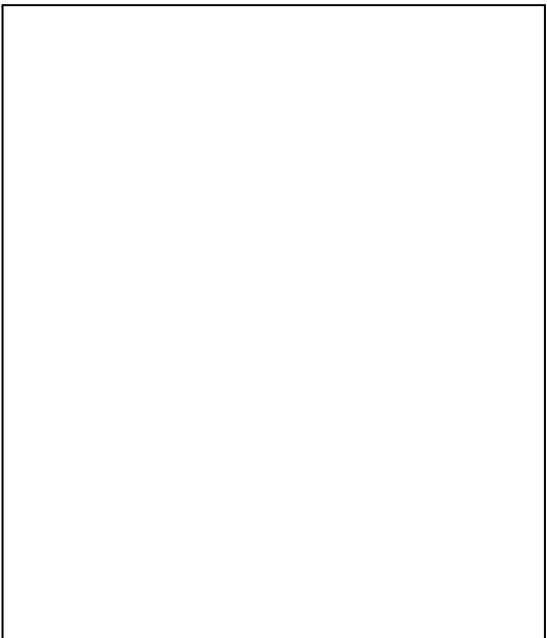
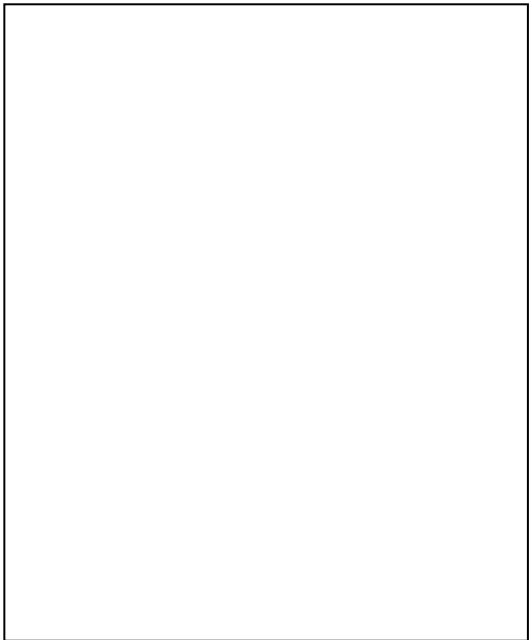

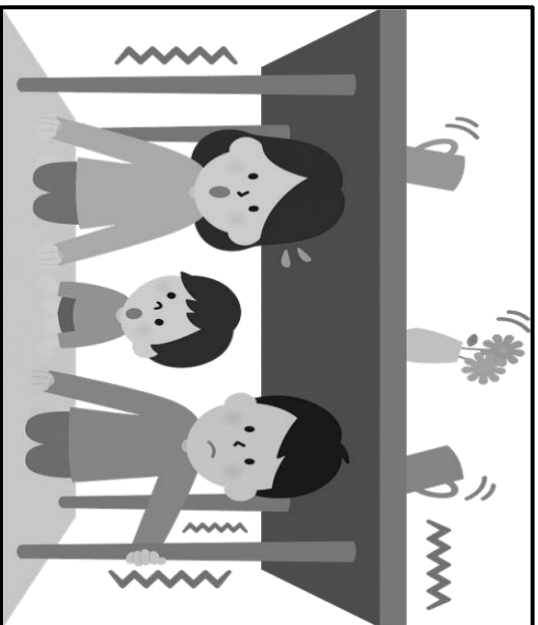
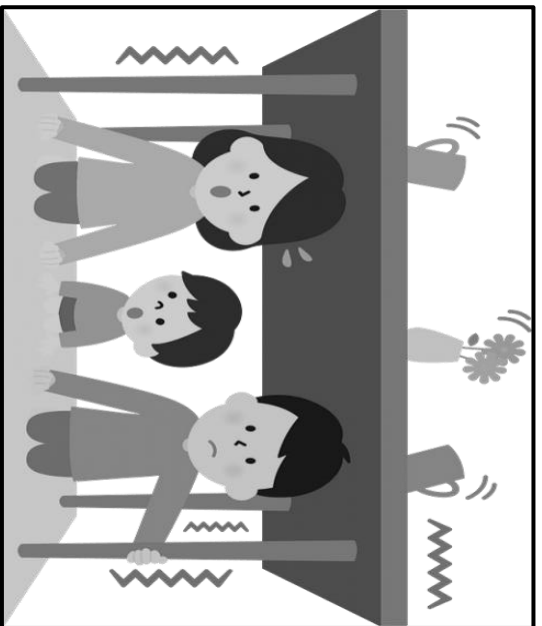
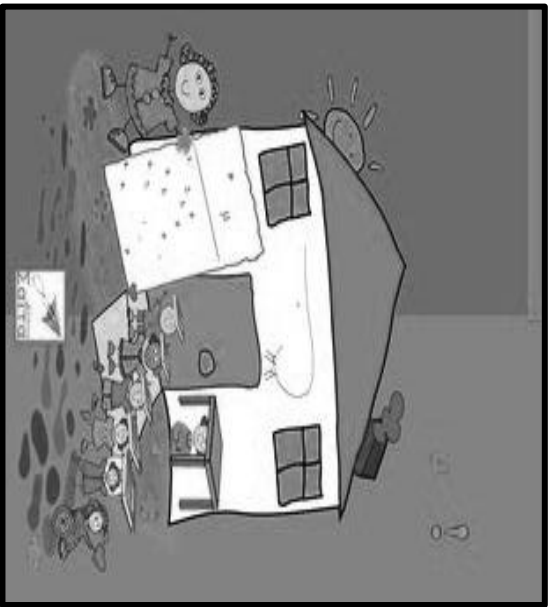
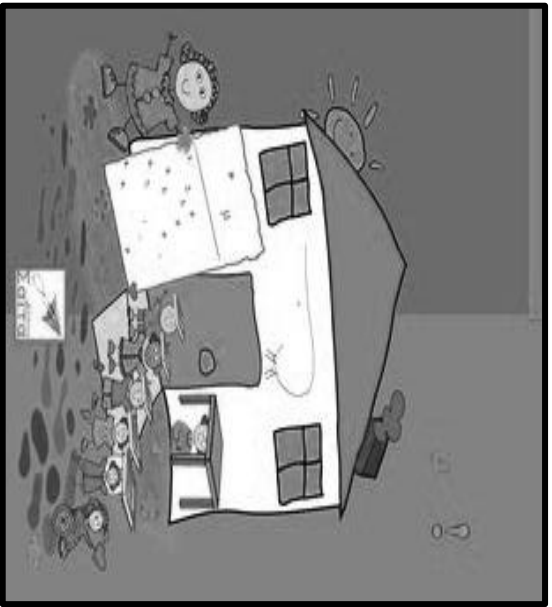
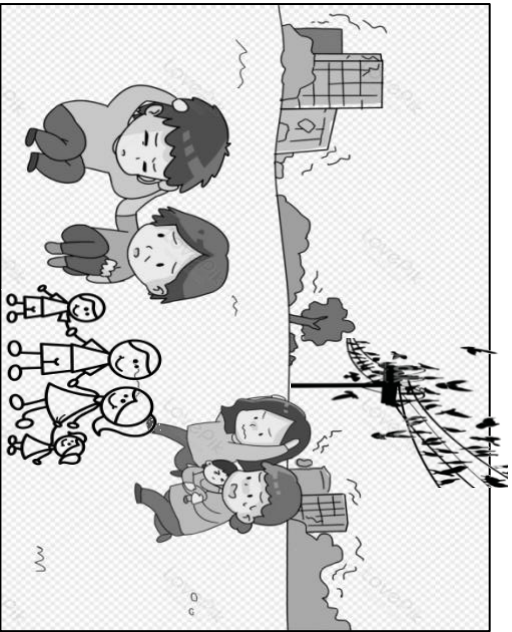
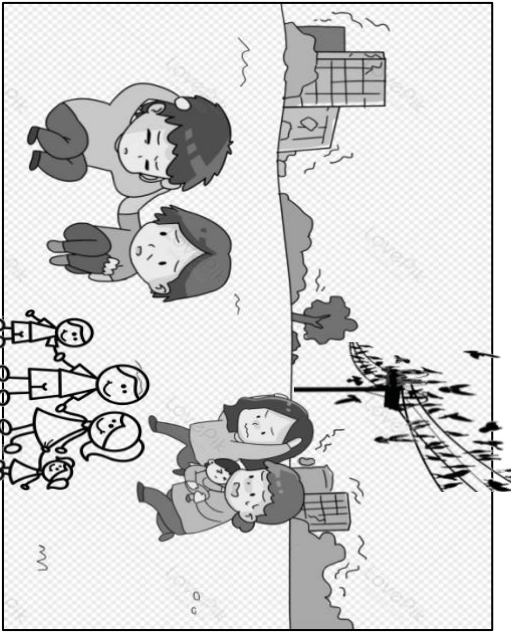





	μ	μ
1.	2.	μ
4.	5.	μ
6.	7.	μ
8.	9.	μ

