



DIGITAL DESIGNER 4.2

Model Name:
Christmas - Rudolf & Santa

Number of Bricks: 101



Step 1 of 43

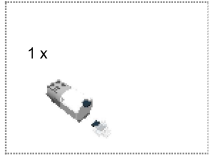

Step 2 of 43

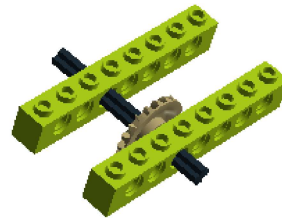
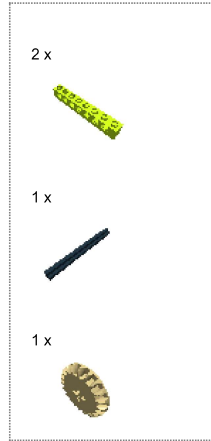

Step 3 of 43

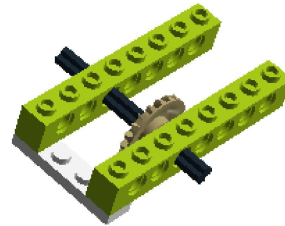
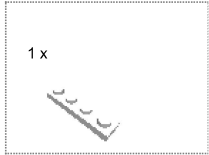

Step 4 of 43

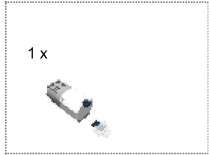

Step 5 of 43

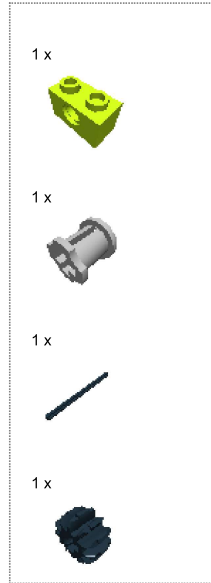

Step 6 of 43

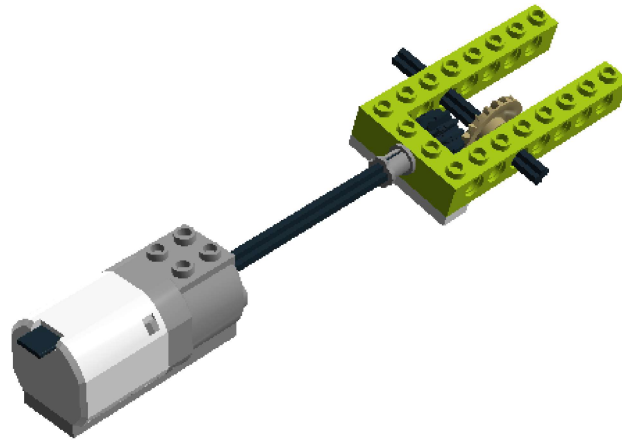

Step 7 of 43

1 x



1 x

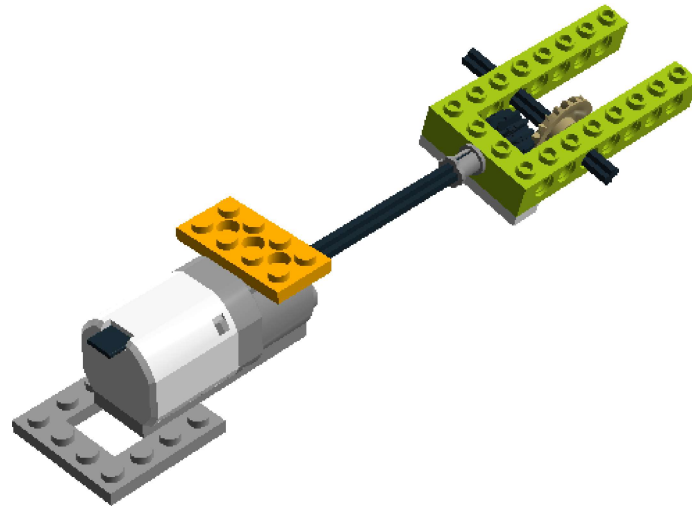

Step 8 of 43

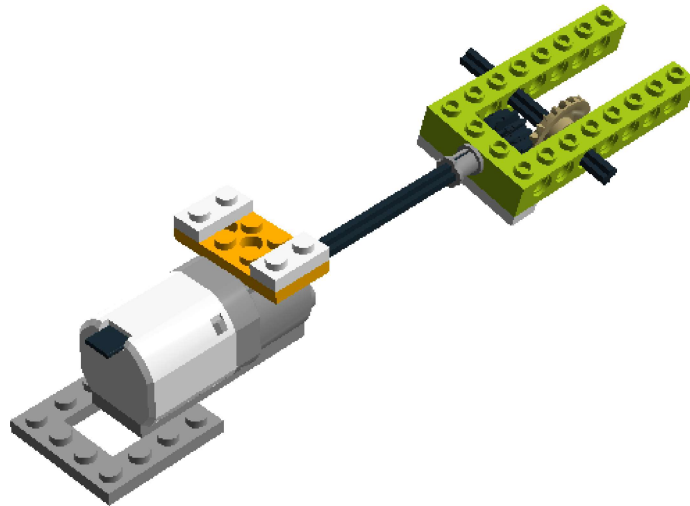
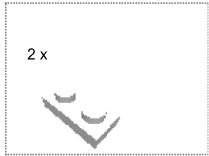

Step 9 of 43

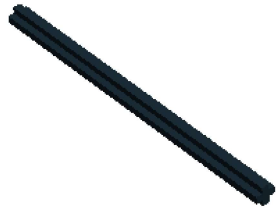

Step 10 of 43

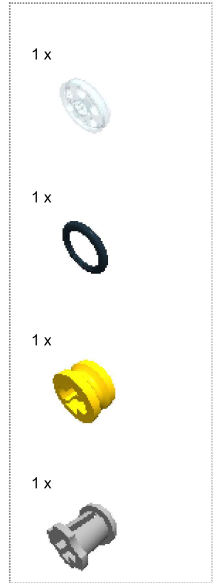

Step 11 of 43

2 x



1 x



1 x



Step 12 of 43



Step 13 of 43

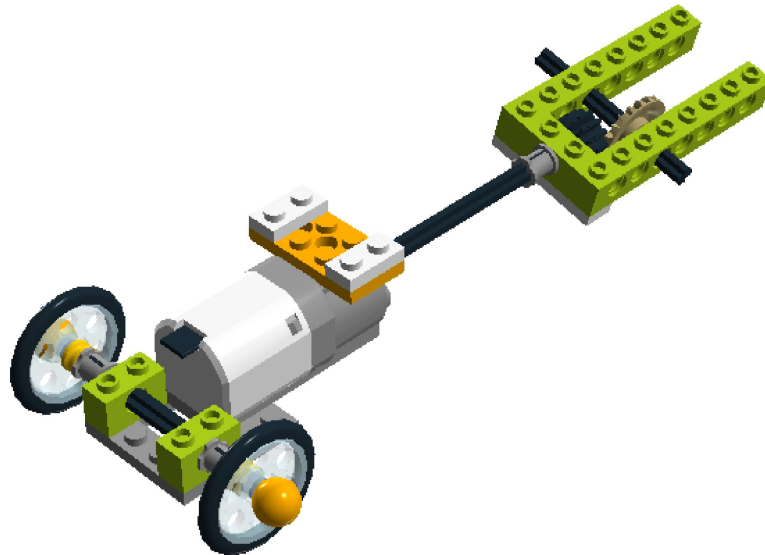

Step 14 of 43

1 x

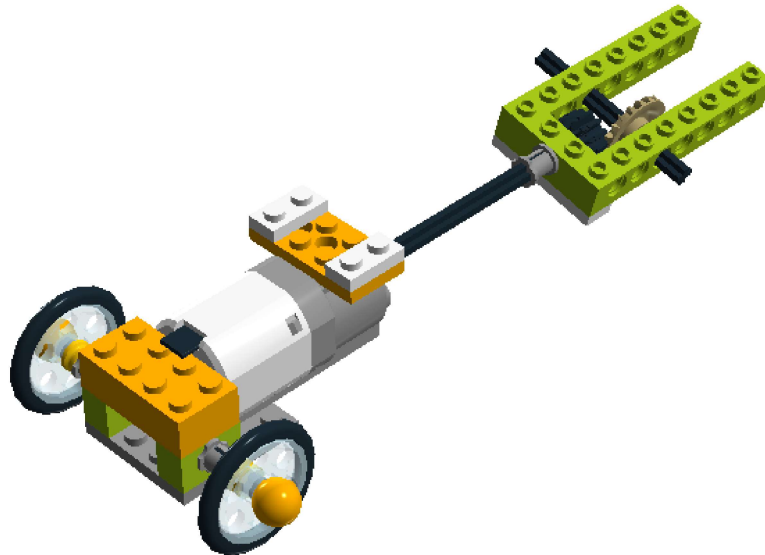

Step 15 of 43

2 x



1 x





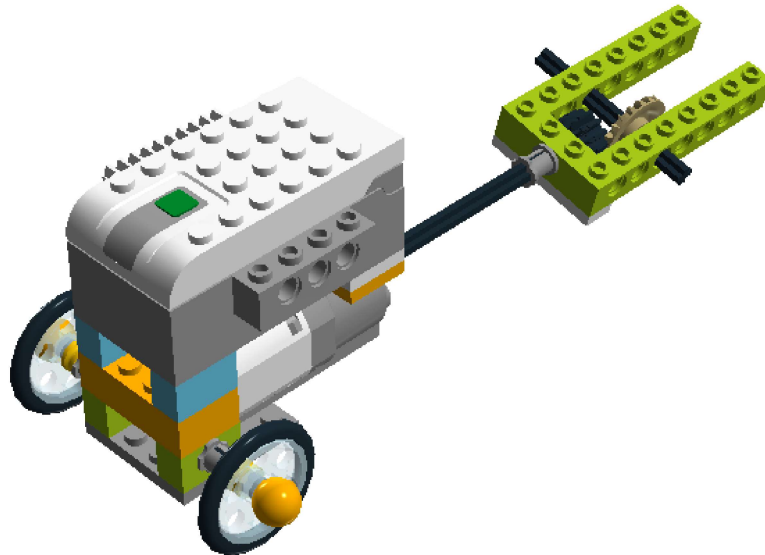

1 x

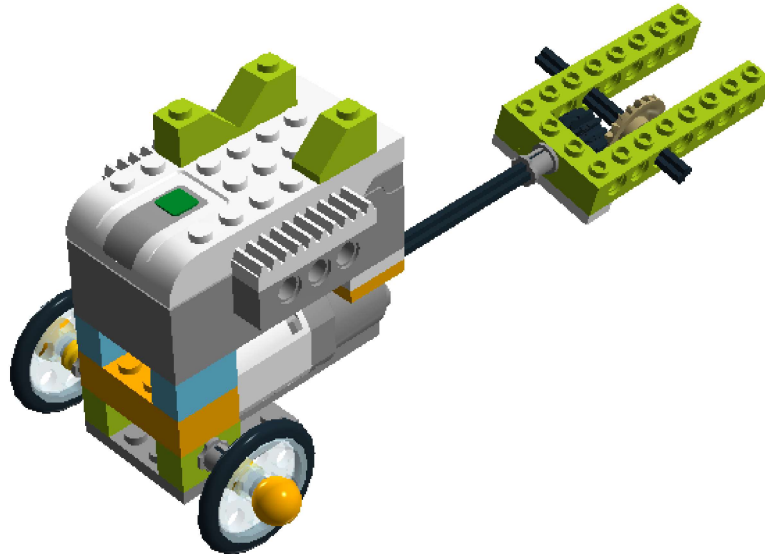
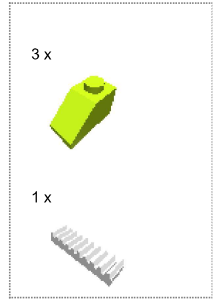

Step 16 of 43



Step 17 of 43

- 1 x 
- 1 x 
- 1 x 
- 1 x 

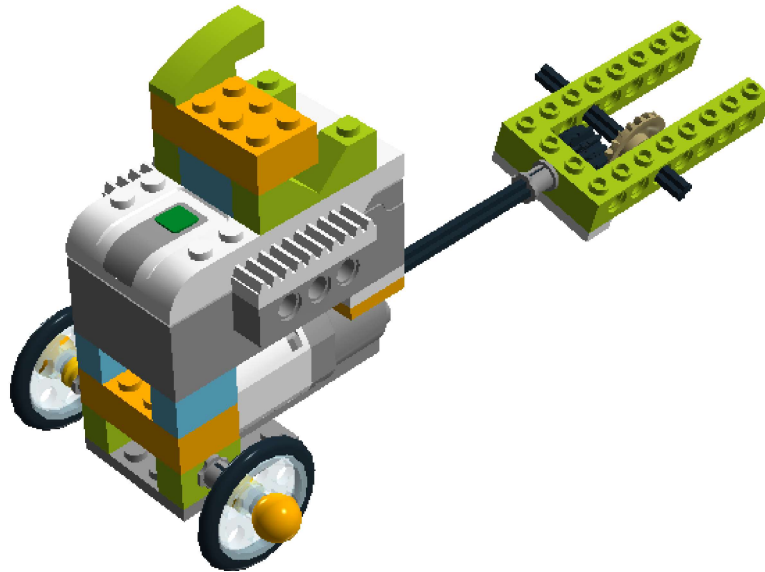

Step 18 of 43

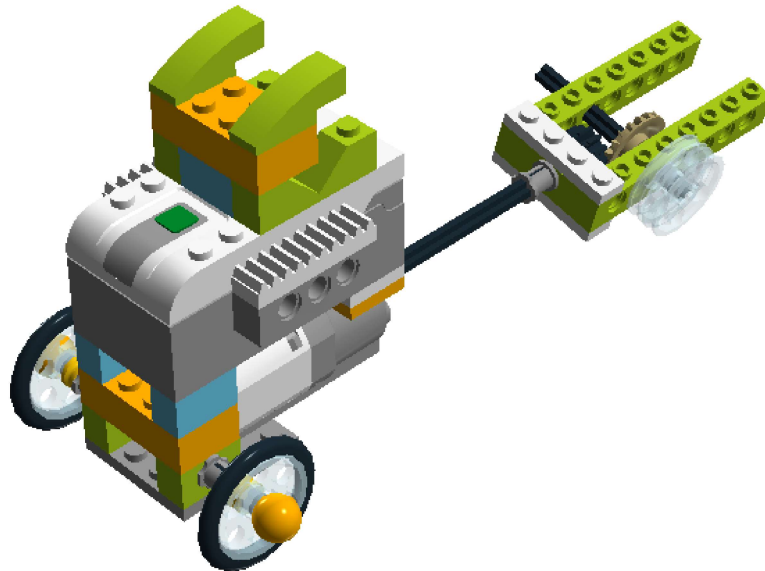
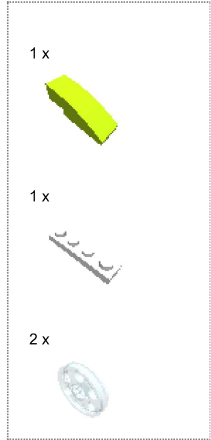

Step 19 of 43

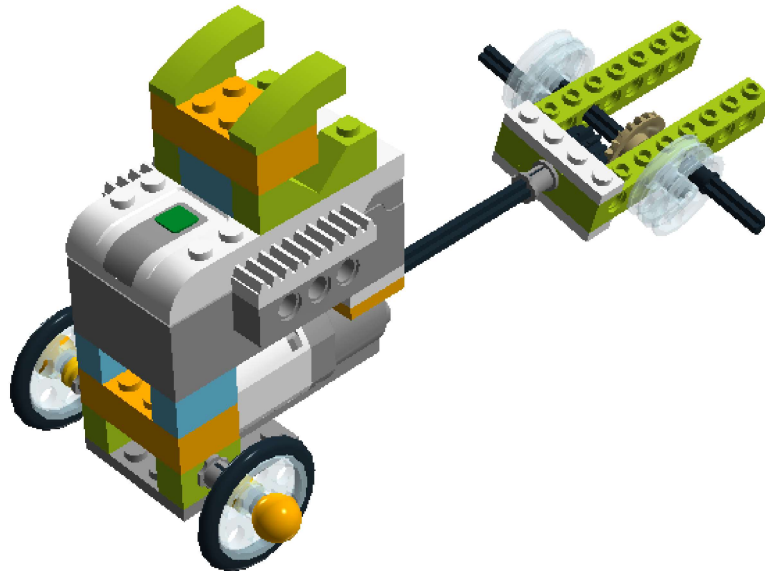

Step 20 of 43

1 x



1 x

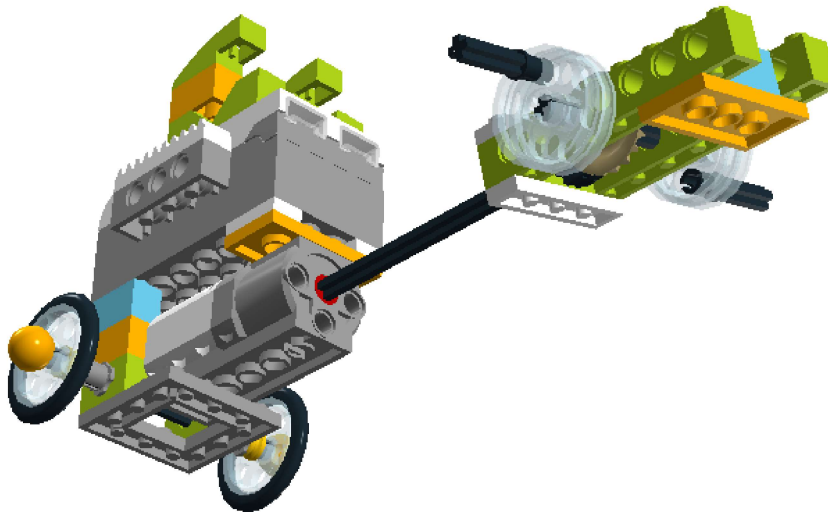

Step 21 of 43

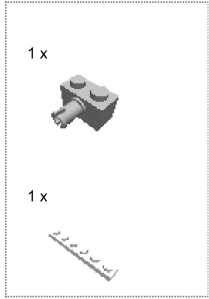

Step 22 of 43

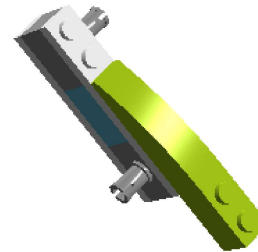
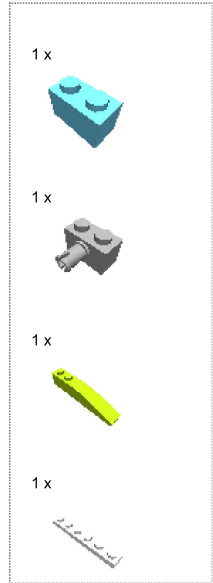

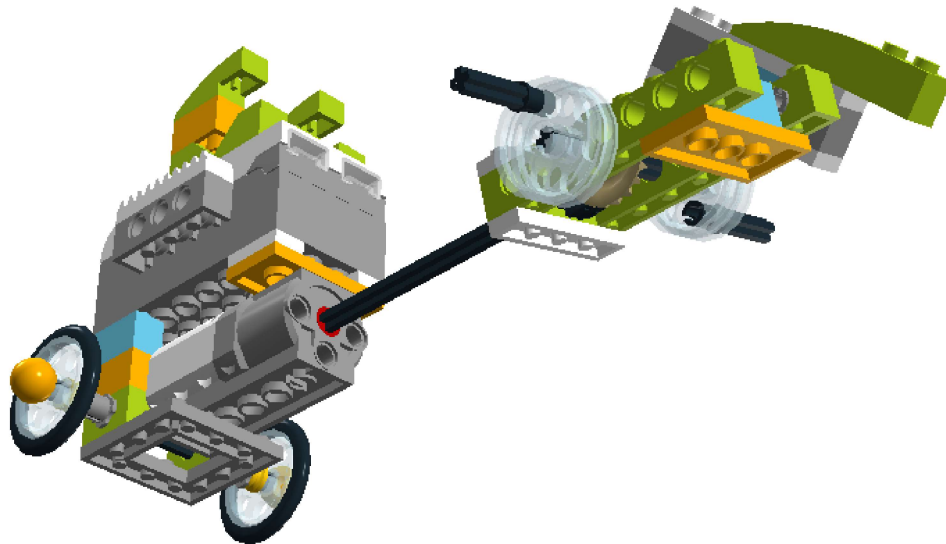

Step 24 of 43

1 x



2 x



1 x



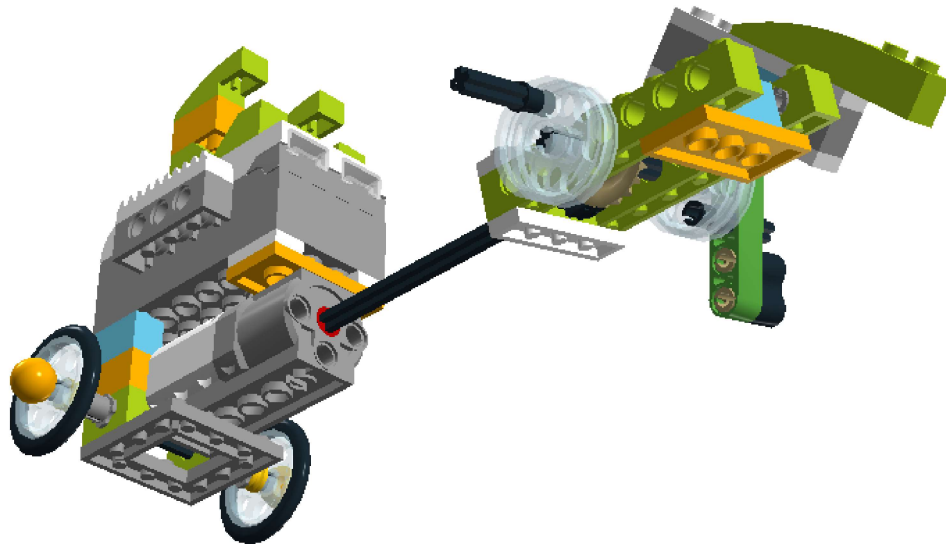

Step 26 of 43

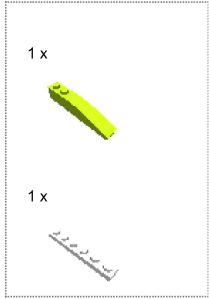

Step 27 of 43

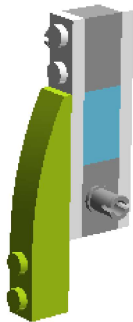
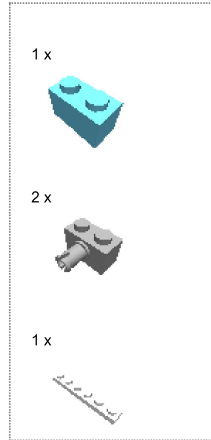

Step 28 of 43

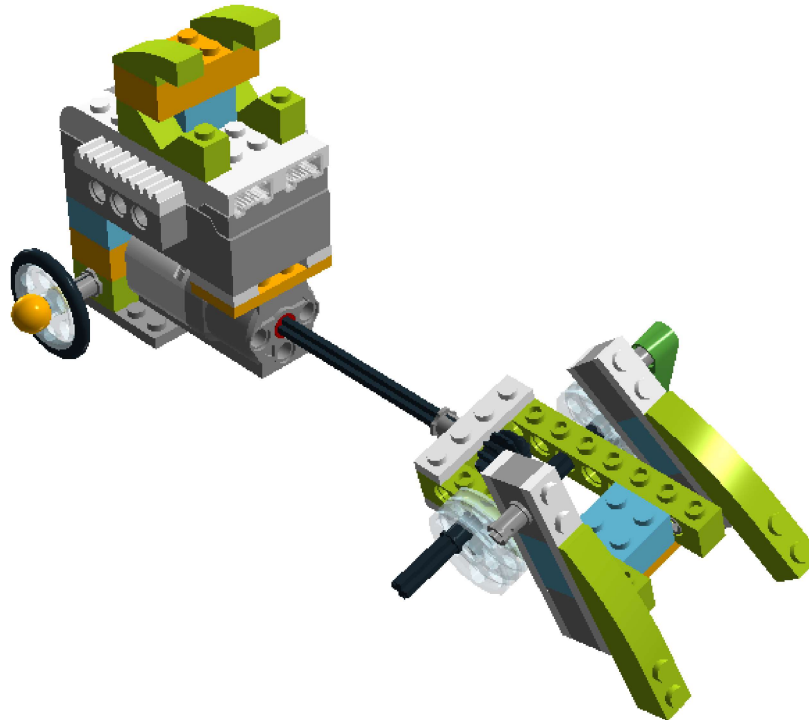

Step 29 of 43

1 x



2 x



1 x

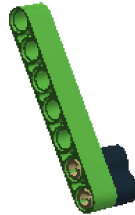

Step 30 of 43



Step 31 of 43

1 x



1 x



1 x



Step 32 of 43

1 x



1 x



Step 33 of 43

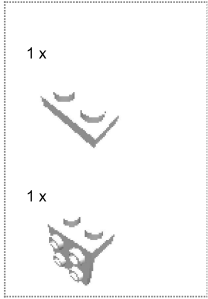

Step 34 of 43

2 x



1 x



1 x



Step 35 of 43



Step 36 of 43

1 x



1 x



1 x

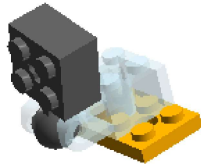

Step 37 of 43

1 x



2 x



1 x

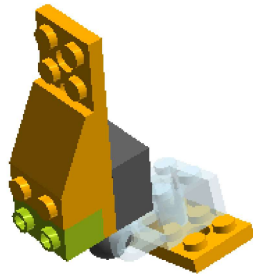

Step 38 of 43

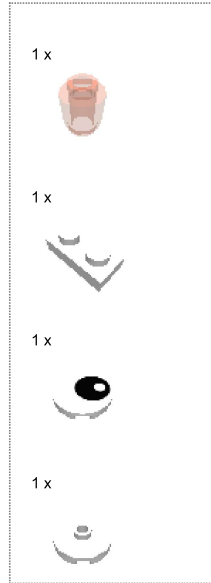

Step 39 of 43

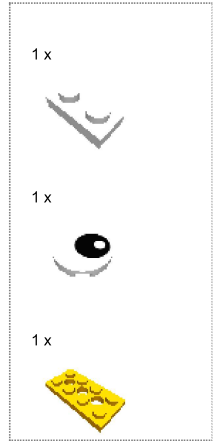

Step 40 of 43

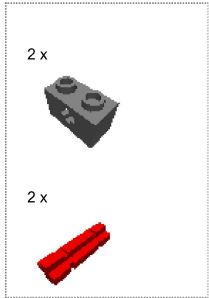

Step 41 of 43

2 x











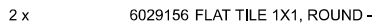
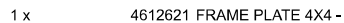
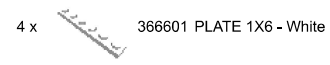
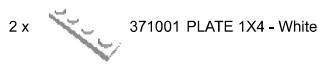
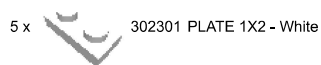
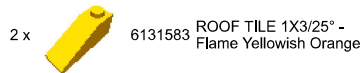
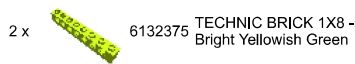
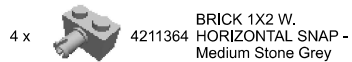
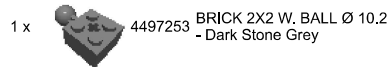
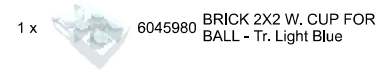
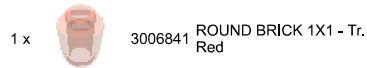
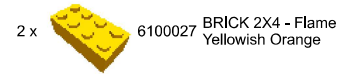
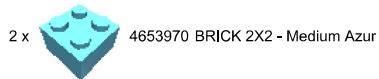
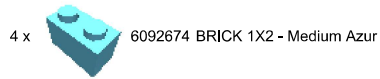









Step 42 of 43



Step 43 of 43







	Medium Stone Grey	White	Green
			
2 x	 6060734 FLAT TILE 2X2, ROUND - White	1 x  6055313 FLAT TILE 2x2 ROUND W. HOLE Ø4.85 - Dark Stone Grey	1 x  6093053 PLATE ROUND W. 1 KNOB - White
4 x	 6132408 PLATE 2X4, 3XØ4.9 - Flame Yellowish Orange	1 x  6117940 ANGLE PLATE 1X2 / 2X2 - White	1 x  6132409 PLATE 2X6 W. HOLES - Flame Yellowish Orange
6 x	 6096296 WEDGE-BELT WHEEL Ø24 - Tr. Light Blue	2 x  6028041 TYRE FOR WEDGE-BELT WHEEL - Black	2 x  6127110 LPF2.0 MEDIUM MOTOR - White, Bright Red, Black, Transparent, Medium Stone Grey
1 x	 6181656 LPF2 SMART HUB 2 I/O 4X8X3 - White, Dark Green, Transparent, Medium Stone Grey	2 x  6097392 TECHNIC 7M BEAM - Bright Green	2 x  4239601 1/2 BUSH - Bright Yellow
2 x	 4142865 2M CROSS AXLE W. GROOVE - Bright Red	1 x  4211815 CROSS AXLE 3M - Medium Stone Grey	4 x  4666579 CONNECTOR PEG/CROSS AXLE - Brick Yellow
3 x	4211622 BUSH FOR CROSS AXLE - Medium Stone Grey	2 x 6089119 Cross axle 2m w. snap w. fric. - Black	2 x 4198367 DAMPER 2M - Black





1 x  370626 CROSS AXLE 6M - Black

2 x  373726 CROSS AXLE 10M - Black

2 x  6097773 ANGLE ELEMENT 135 DEG. [4] - Bright Yellowish Green

2 x  4250465 TOOTHED BAR M=1, Z=10 - White

1 x  4177431 DOUBLE CONICAL WHEEL Z12 1M - Black

1 x  6031962 BEVEL GEAR Z20 - Brick Yellow

2 x  6071608 VOODOO BALL Ø10,2 - Flame Yellowish Orange

1 x  6000020 FLOWER - Bright Red

© 2012 The LEGO Group. All rights reserved.
Use of the LEGO Digital Designer html print tool, signifies your agreement to the terms of use.